

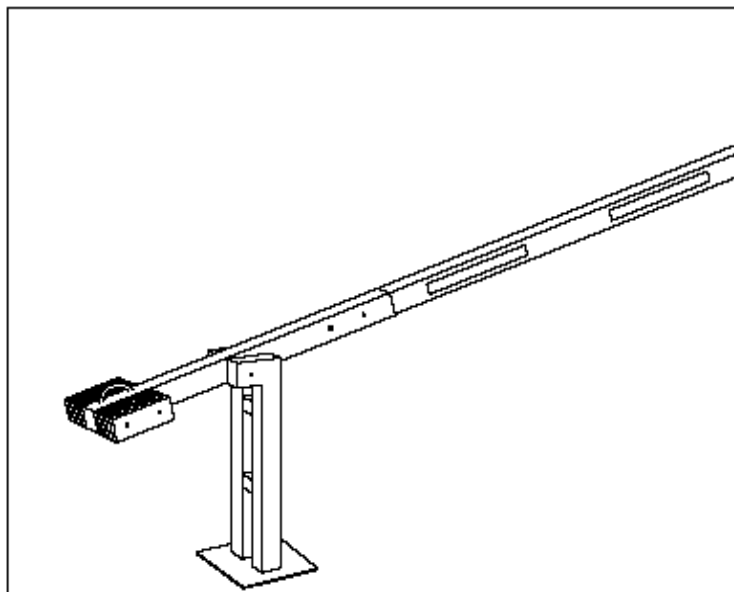





Handschraken bis 7,50 m Sperrbreite



Die entscheidenden Vorteile:

-  Schrankenständer aus verzinktem Stahl, RAL 3002
-  Automatische Arretierung durch Rastbolzen bei geöffneter und geschlossener Schranke
-  Baufaufnahme links/rechts verwendbar ohne Umbau
-  optimale Laufeigenschaften durch Polymer-Gleitlager und Gegengewichts-Platten
-  optimaler Vandalismusschutz

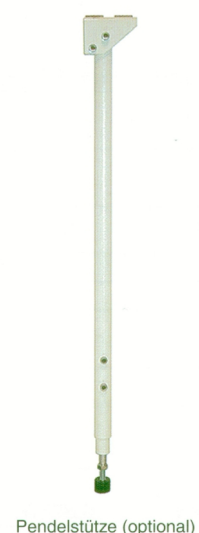
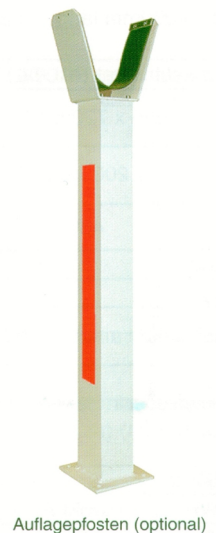
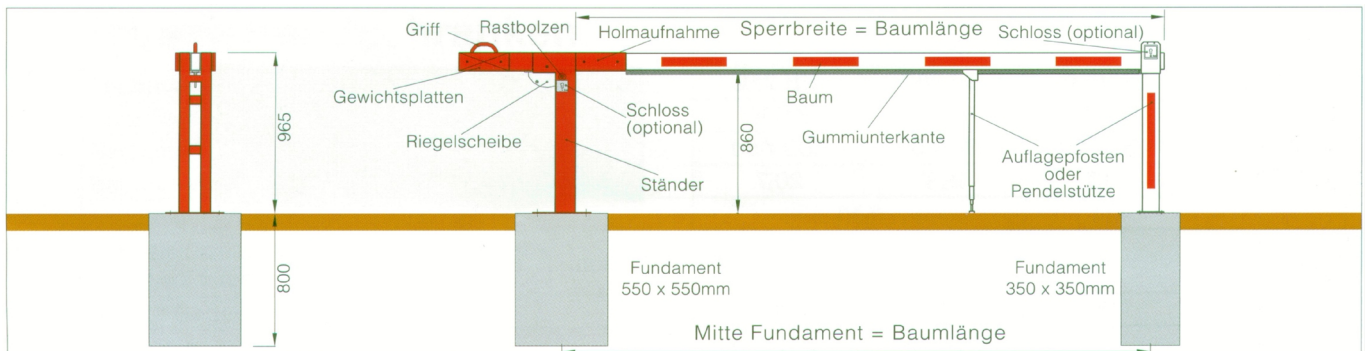
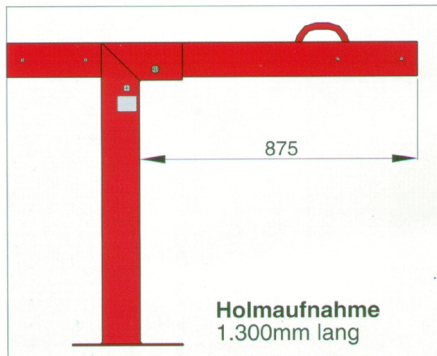

Technische Daten EH 25L – EH 75L

Modell	EH 25 L	EH 30 L	EH 35 L	EH 40 L	EH 45 L	EH 50 L	EH 55 L	EH 60 L	EH 65 L	EH 70 L	EH 75 L
Sperrbreite (mm)	2.500	3.000	3.500	4.000	4.500	5.000	5.500	6.000	6.500	7.000	7.500
Anzahl der Gegen-Gewichte ohne Pendelstütze	0	2	2	2	4	6	12	14	16	18	20
Anzahl der Gegen-Gewichte mit Pendelstütze	2	4	4	4	6	8	14	16	18	20	22
Gesamt-Gewicht (kg) ohne Pendelstütze	45	54	55	56	64	73	102	110	119	127	136
Gesamt-Gewicht (kg) mit Pendelstütze	54	62	63	64	73	81	110	119	127	136	145

